

Sol kapak  
Geçiş ölçüsü

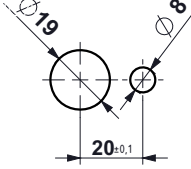

Sağ kapak  
Geçiş ölçüsü

Farklı kapı kalınlıkları için, lütfen satış ekibimiz ile temasa geçin.



DT
30
40
50
60
70
80

- 1: Kol
- 2: Kilitleme Grubu
- 3: Sabitleyici
- 4: Emniyet Kolu (Opsiyonel - 112A101)
- 5: Emniyet Kilit Kolu (Opsiyonel - 112A2)

YÖN UYGULAMASI

Sağ kapak	001	
Sol kapak	002	

112

KLİMA SANTRAL KİLİDİ



- Ergonomik ve estetik kol
- Hızlı montaj
- Güçlü kilitleme yapısı
- Ayarlı dil sayesinde ayarlanabilir kilitleme aralığı
- İçeride doğru açılan kapılar için uygundur.

MALZEME

GÖVDE:	Polyamide DIN-EN ISO 1043-1 PA6 GFR 30
KOL:	PA6 GFR 30
DİL:	Çelik - PA6 GFR 30
CONTA:	Poliüretan



Fişesiz

Göbekli



Asma kilit uygulaması

SİLİNDİR - FİŞE	DD
Silindirsiz - fişesiz	00
Aynı şifre (Paslanmaz toz kapaklı)	03
Farklı şifre (Paslanmaz toz kapaklı)	32
Euro key (5333)	05

GÖBEK	DD
8 mm Kare	28
10 mm Kare	20
7 mm Üçgen	37
8 mm Altıgen	68

Grup kodu	Versiyon	Kapı kalınlığı	Silindir Göbek	Dil	Asma kilit*	Yön Uygulaması
112	2	DT	DD	CC		

\*: Asma kilit uygulaması için "1" ekleyiniz.

Diller için sayfa: 122

Aksesuarlar için sayfa: 123 - 124

Anahtarlar için sayfa: 124

## KOLLAR

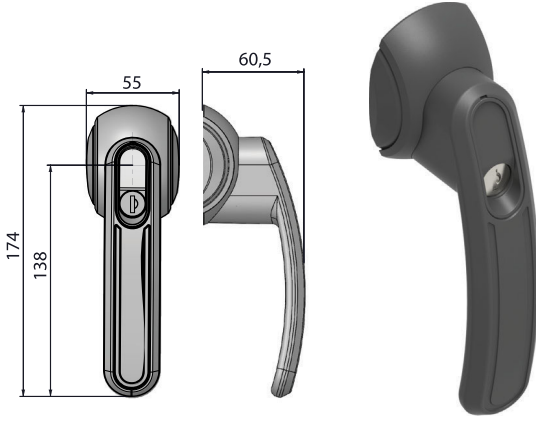

Dışa doğru açılır kapılar için uygundur.

Grup kodu	Versiyon	Silindir Göbek	Asma kilit*
112H	1	DD	

\*: Asma kilit uygulaması için "1" ekleyiniz.

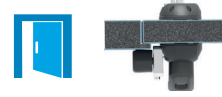
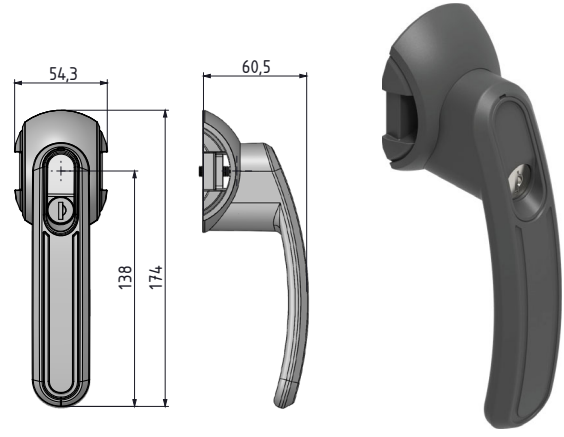

İçe doğru açılır kapılar için uygundur.

Grup kodu	Versiyon	Silindir Göbek	Asma kilit*
112H	2	DD	

\*: Asma kilit uygulaması için "1" ekleyiniz.



Kollar harici olarak temin edilebilir.  
Kilitleme grubu ve şaft parçalarını içermez.

## DİLLER



Sabit Dil  
(Yuvarlak makaralı)



Sabit Dil  
(Üçgen makaralı)



Ayarlı Dil  
(Yuvarlak makaralı)



Ayarlı Dil  
(Üçgen makaralı)

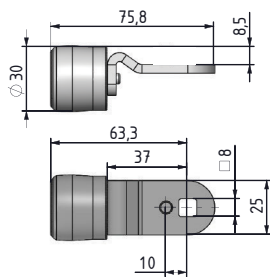

STOK KODU	CC
112C01	01
* 112C11	11

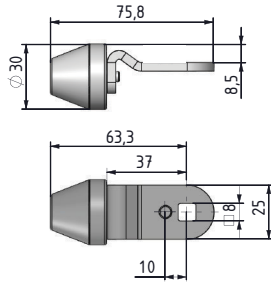

STOK KODU	CC
112C02	02
*112C12	12

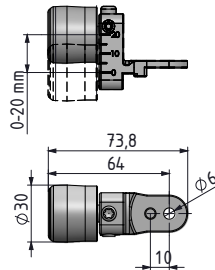

STOK KODU	CC
112C03	03

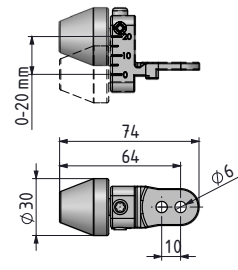

STOK KODU	CC
112C04	04

\*: Yalnızca çoklu kilitleme sistemi için

\*: Yalnızca çoklu kilitleme sistemi için



## AKSESUARLAR

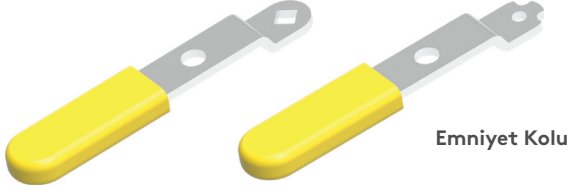

Emniyet Kolu



Emniyet Dili

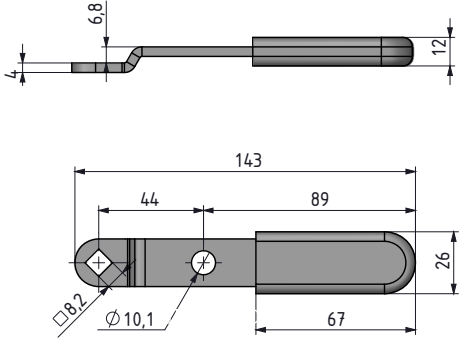

STOK KODU  
112A102

⚠ Versiyon 4 de kullanılır.

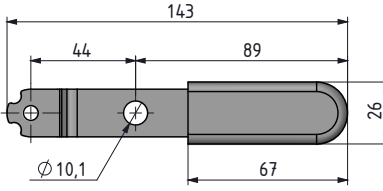

STOK KODU  
112A101

Versiyon 1,2,3 de kullanılır.

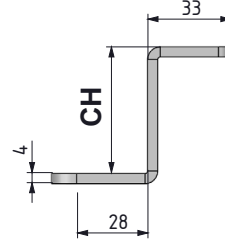

CH
25
50
75
100

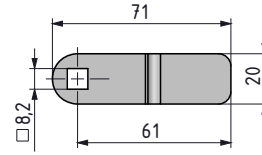

STOK KODU  
112A3CH02

⚠ Versiyon 4 de kullanılır.

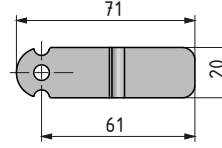

STOK KODU  
112A3CH01

Versiyon 1,2,3 de kullanılır.



Emniyet Kilit Kolu

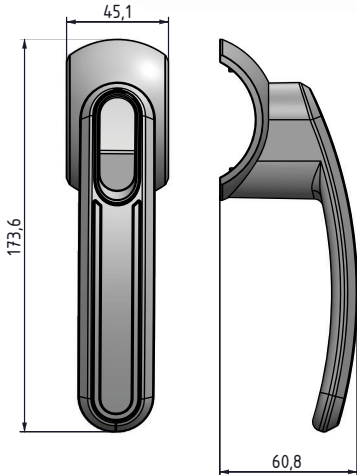

STOK KODU  
112A2



Çoklu kilitleme ünitesi

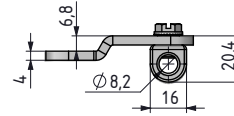

STOK KODU  
112A502

⚠ Versiyon 4 de kullanılır.

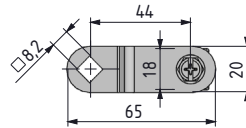

STOK KODU  
112A501

Versiyon 1,2,3 de kullanılır.

## AKSESUARLAR



Çubuk tutucu

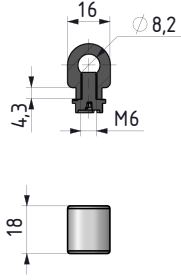

STOK KODU  
112A4



Çubuk

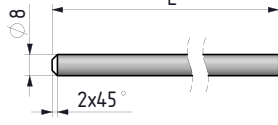

GRUP KODU UZUNLUK  
112IC L



Kapak

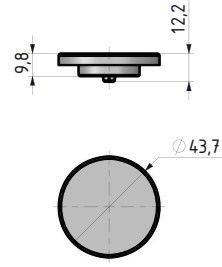

STOK KODU  
112A6

## ANAHTARLAR



8 mm Kare

STOK KODU  
36828



10 mm Kare

STOK KODU  
36820



7 mm Üçgen

STOK KODU  
36837



8 mm Altıgen

STOK KODU  
36868

## ÇOKLU KİLİTLEME SİSTEMİ

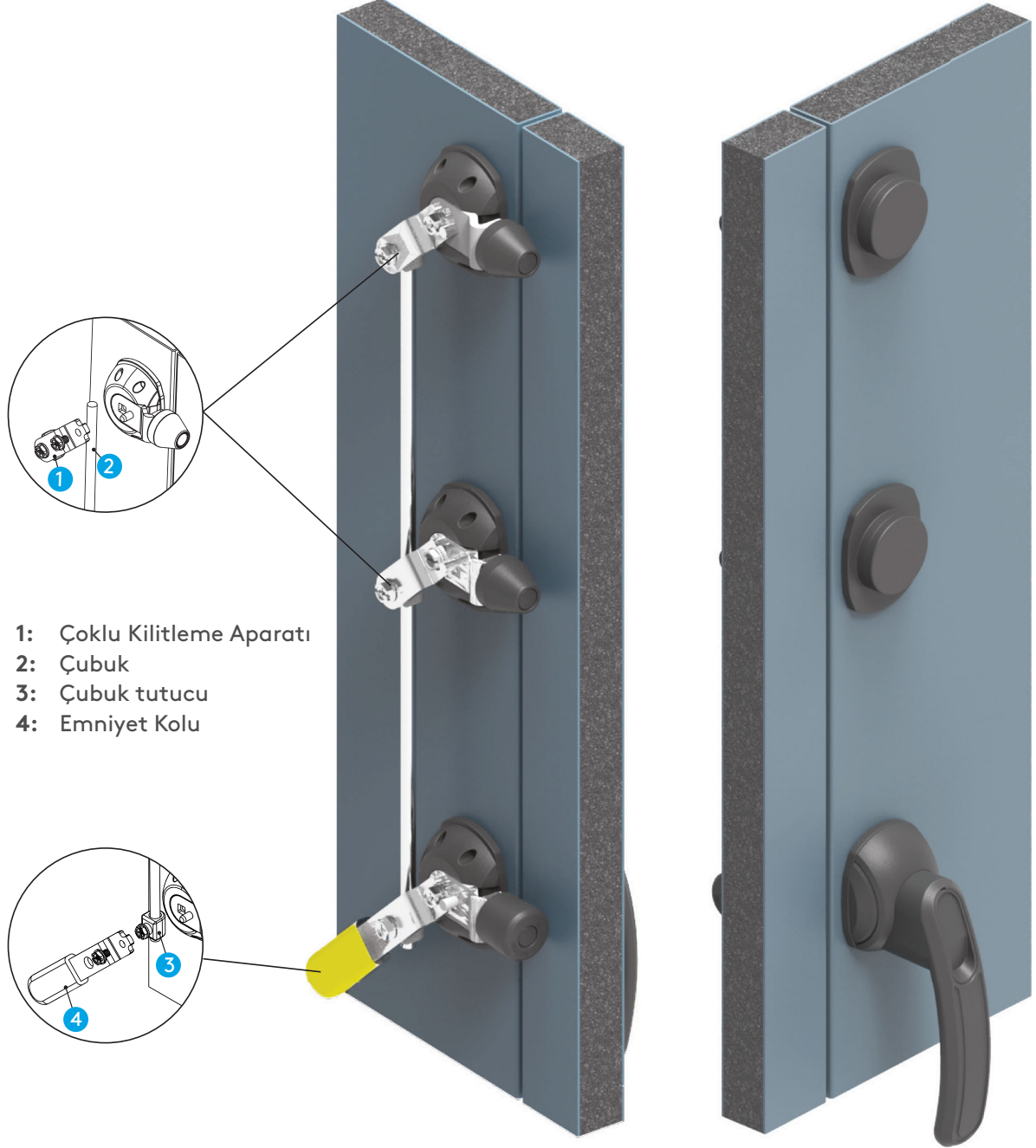

- 1: Çoklu Kilitleme Aparatı
- 2: Çubuk
- 3: Çubuk tutucu
- 4: Emniyet Kolu

Uzun kapaklarda veya çoklu kilitlemelerde çubuk ve çubuk tutucu aksesuarlarla talep edilen ölçülerde farklı çözümler yapılabilir. Çoklu kilitleme için satış ekibimizden gerekli teknik desteği alabilirsiniz. (Görseldeki örnek uygulamadır.)